

MICRO INVERTER



Wireless Series-R3
Micro Inverter

WVC-350

USER MANUAL

..... Green Energy
..... Smart Inverter **Expert**

IoT Monitoring Platform Smart mobile "core" life

- CO-2 induced environmental analysis
- Daily and total energy generation in kWh
- Actual DC input voltage, current and power
- Actual AC output voltage, current and power
- Inverter temperature
- Historical (daily, weekly, monthly) power curve
- Power losses due to weather induced effects
- Optional limitation of power output
- Online switch for the inverter start stop

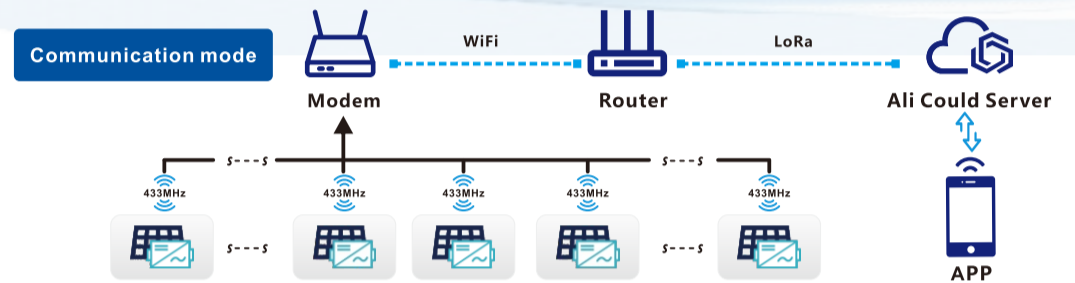

- ☑ CO-2 induced environmental analysis
- ☑ Daily and total energy generation in kWh
- ☑ Actual DC input voltage, current and power
- ☑ Actual AC output voltage, current and power
- ☑ Inverter temperature
- ☑ Optional limitation of power output
- ☑ Online switch for the inverter start stop
- ☑ Historical (daily, weekly, monthly) power curve

model	WVC-350	
Recommend use panels	1*435Watt	
Output voltage mode	120/230V Auto switch	
PV Open circuit voltage	30-54VOC	
Operating voltage range	22-60V	
Starting voltage range	22-60V	
short-circuit current	18A	
Maximum working current	16A	
Output parameters	@120V	@230V
Output peak power	350Watt	350Watt
Rated output power	330Watt	330Watt
Output current	2.91A	1.52A
AC voltage range	80-160VAC	180-280VAC
AC frequency range	48-51Hz/58-61Hz	48-51Hz/58-61Hz
Power factor	>95%	>95%
Number of branch connections.	15PCS (Single)	25PCS (Single)
Output efficiency	@120V	@230V
Static MPPT efficiency	99.5%	99.5%
Max output efficiency	95%	95%
Loss of power at night	<0.5W	<0.5W
Total current harmonics	<5%	<5%
Appearance and technical features		
Temperature range	-40°C to +65°C	
Size (L×W×H)	165mm×176mm×38mm	
Net amount	0.82kg	
Waterproof grade	Ip65 NEMA3R	
Heat dissipation mode	Self-cooling	
Communication mode	433MHz	
Power transmission mode	Reverse transmission, Load priority	
monitoring system	APP	
Electromagnetic Detection	EN61000-6-1:2007 EN6100-6-3:2007+A1:2011+AC:2012	
Power Grid standard	EN50549-1、 EN 50549-2、 NBR 16149:2013、 UL1741	
Power grid detection	IEC/EN 62109-1、 IEC/EN 62109-2、 IEC 62116、 IEEE 1547	
Certificate	CE , ETL , Patented technology	
Packing weight		
Specifications	Each (Packing)	Box (15PCS)
weight	1.28 KG	19.5 KG
Size	245×202×60mm	450×395×345mm

Detailed



System diagram

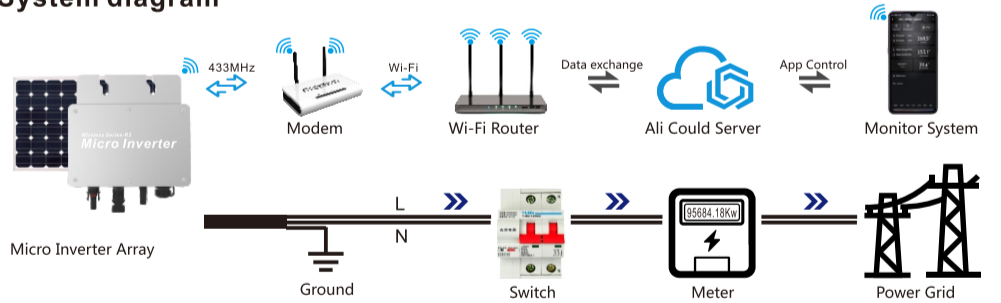

Description of the connector and cable core of the micro inverter

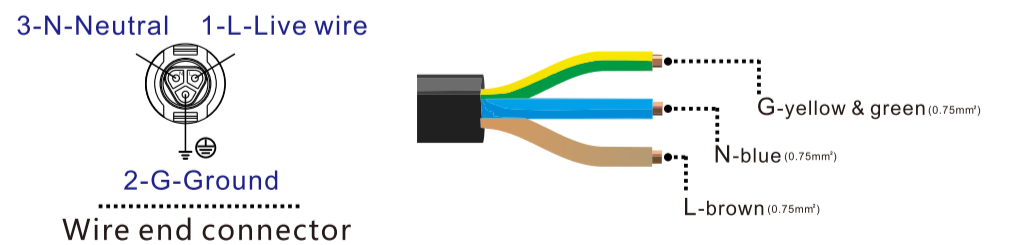

Note: You can purchase a professionally customized AC bus with a T-type connector. Use this AC bus as the AC bus for each branch. Connect it hand in hand to form a modular micro-inverter branch wiring system.

LED indicator function of micro inverter

1. Red light keeps on -----The equipment enters the preparatory working state;
2. Red light flashes -----The device enters the delayed start-up state;
3. Blue light flashes quickly -----MPPT maximum power point search status;
4. Blue light keeps on-----MPPT maximum power point locked state;
5. Blue light turns to red light for a long time-----a) Island protection; b)Frequency protection; c)Fault; d) Software shutdown; e)AC voltage over-voltage protection; f)DC voltage over-voltage protection;

Normal working indicator flashing process

Connect the micro-inverter correctly to the AC and DC terminals and then power on:
The red light keeps on for 3 seconds → the red light flashes for 30 seconds → the blue light flashes quickly (MPPT maximum power point search) → the blue light keeps on, (MPPT lock).

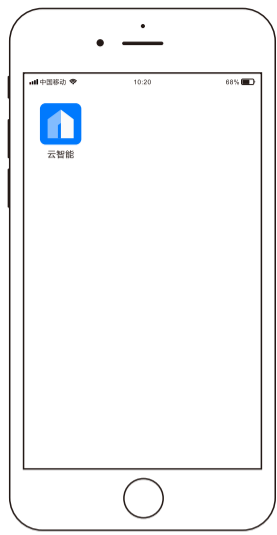

DOWNLOAD Cloud Intelligence APP

Please use the QR code to scan and install the "Cloud Intelligence" client application, System version: Android 5.0, IOS 9 and above



note

- Connect the two communication antennas on the collector (Modem) as required;
- Place the collector in an appropriate location to ensure that the wifi signal source can be received normally and Form a good communication distance with the inverter;
- The connected Wi-Fi network needs to be in 2.4G communication mode;
- Please reset the collector for the first use;



Reset

Press and hold the reset button for more than 5 seconds, and Reday will go out and light up again after 5 seconds. Release the button at this time, and the device will complete the reset.

1 Add device

Open the intelligent monitoring software "Cloud Intelligence" APP to log in Account, click the "+" icon in the upper right corner to start adding.

*If a device has been created under the current account, (You can click on the device icon below to enter the details page for query or operation)

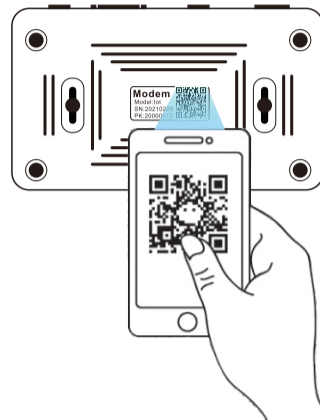

2 Entry equipment

When the smart APP changes to the QR code scanning state, scan the QR code label at the bottom of the Modem. At this time, the APP will automatically collect the body code of the Modem, and automatically jump to the Wi-Fi connection page, and enter the current Wi-Fi Click Next after the password;

3 Distribution network

Connect the Modem to the power supply as required, and quickly press the "Reset" button. When the "Reday" indicator turns from a long on state to a fast flashing state, the Modem will enter the network distribution state;

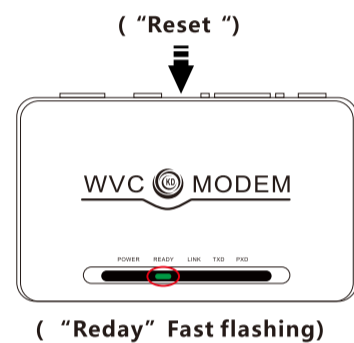

4 Initialization

After completing the network configuration of the modem, return to the phone initialization device operation page, check the "I have completed the above operations" below and click the "start connection" button, then the page will jump to the signal search page and the Link on the modem The indicator light will become a fast flashing state. When a WiFi signal is found, the indicator light will flash slowly until the network configuration is completed, and the indicator light will return to a steady state. The page jumps to the completion page, please click "Finish"

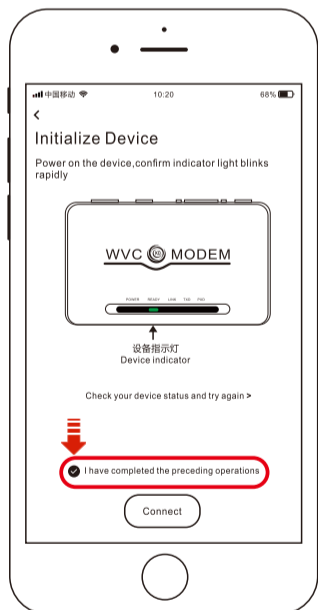

Features

Smart APP can realize real-time data transmission with the cooperation of Alibaba Cloud IoT Through graphs and graphic displays in time, users can understand the operation of the power station. The user can monitor the operation and adjust the output power function of the system.

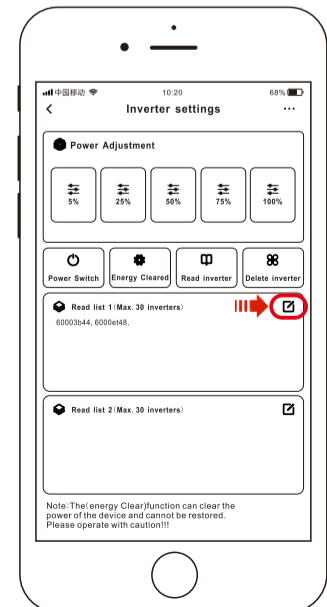
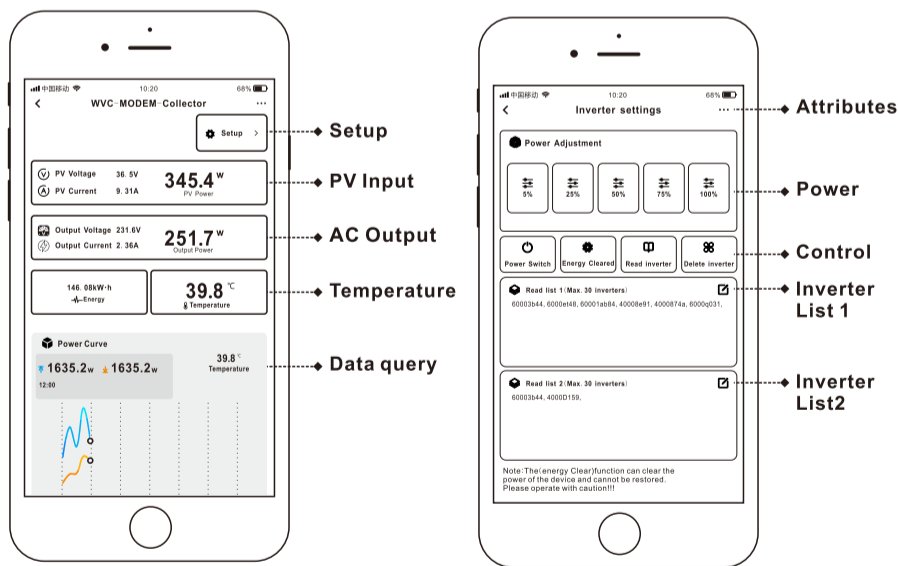

5 Add inverter

When the initialization is completed, please click the "Settings" menu in the upper right corner, find the inverter list item on the setting page, click the "Edit" button, and fill in the 8-digit code on the inverter to complete the inverter Add to.

Remarks

- When multiple inverters need to be added, the In the English state, "," comma separated and ended. Such as: 60001234, 6000E312,
- Each Modem can monitor 60 inverters at the same time; 3. A total of 2 lists, each list can be filled with 30 inverter codes;



INTELLIGENT IoT MONITORING MODEM
 Number of data collectors per Modem
 Built-in WiFi IoT data terminal
 Can be used on any smart device (Android/iOS)

- CO-2 induced environmental analysis
- Daily and total energy generation in kWh
- Actual DC input voltage, current and power
- Actual AC output voltage, current and power
- Inverter temperature
- Historical (daily, weekly, monthly) power curve
- Power losses due to weather induced effects
- Optional limitation of power output
- Online switch for the inverter start stop